

# T-1 3/4 PACKAGE SOLID STATE LAMP

## MVL-514HTG

### Description

The MVL-514HTG, a Green source color device, is made with InGaN on Sapphire substrate LED die. The package is T-1 3/4 (5mm) water clear plastic lens package.

### Applications

- Full color displays & moving message signs
- Solid state incandescent replacement bulbs
- High ambient panel indicators
- Medical & Analytical instruments

### Features

- High performance
- Excellent chip to chip consistency
- High reliability

### Package Dimensions

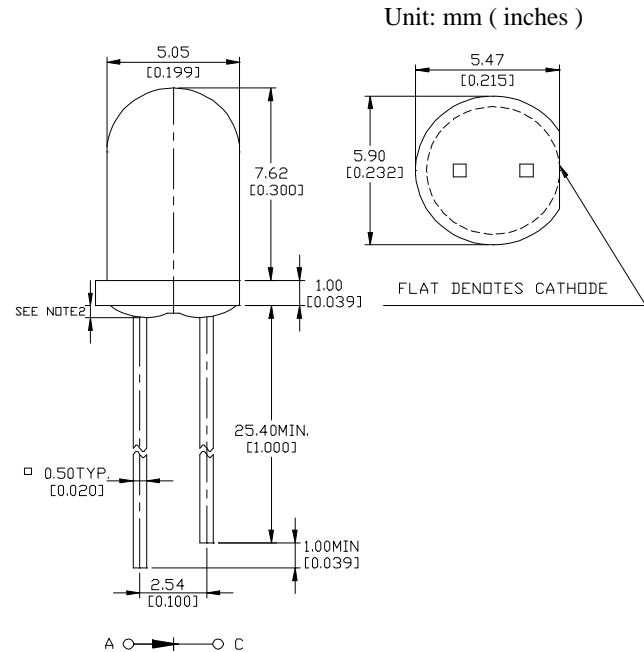

Notes :

1. Tolerance is  $\pm 0.25$  mm (.010") unless otherwise noted.
2. Protruded resin under flange is 0.8 mm (.031") max.
3. Lead spacing is measured where the leads emerge from the package.

### Absolute Maximum Ratings

@  $T_A = 25^\circ\text{C}$

Parameter	Symbol	Maximum Rating	Unit
Peak Forward Current(1/10 Duty Cycle@ 1KHz )	$I_{pf}$	100	mA
Continuous Forward Current	$I_{af}$	30	mA
Reverse Voltage	$V_R$	5	V
Operating Temperature Range	$T_{opr}$	-20°C to + 80°C	
Storage Temperature Range	$T_{stg}$	-30°C to + 100°C	
Electrostatic Discharge Threshold <sup>Note 1</sup>		300 V	

Notes: 1. Product resistance to electrostatic discharge (ESD) is measured by simulating ESD using a rapid avalanche energy test (RAET). The RAET procedures are designed to approximate the maximum ESD ratings shown. Seller gives no other assurances regarding the ability of Products to withstand ESD.

**UNI**

Unity Opto Technology Co., Ltd.

01/09/2002

## Optical-Electrical Characteristics

@ T<sub>A</sub>=25°C

Parameter	Test Conditions	Symbol	Min .	Typ .	Max .	Unit .
Luminous Intensity	I <sub>F</sub> =20mA	I <sub>V</sub>	1000	2200	-	mcd
Forward Voltage	I <sub>F</sub> =20mA	V <sub>F</sub>	-	3.5	4.2	V
Reverse Current	V <sub>R</sub> =5V	I <sub>R</sub>	-	-	100	μA
Dominant Wavelength	I <sub>F</sub> =20mA	λ <sub>d</sub>	-	525	-	nm
Viewing Angle	I <sub>F</sub> =20mA	2θ <sub>1/2</sub>	-	30	-	deg.

## Typical Optical-Electrical Characteristic Curves

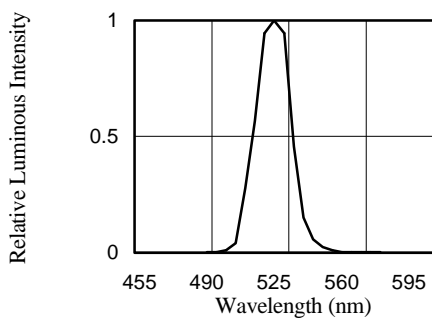

FIG.1 RELATIVE LUMINOUS INTENSITY VS. WAVELENGTH

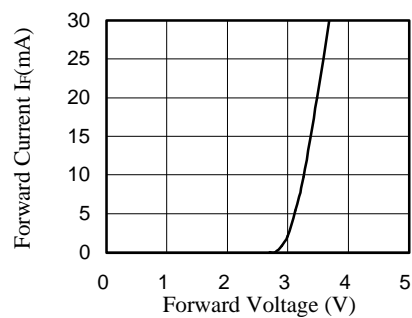

FIG.2 FORWARD CURRENT VS. FORWARD VOLTAGE

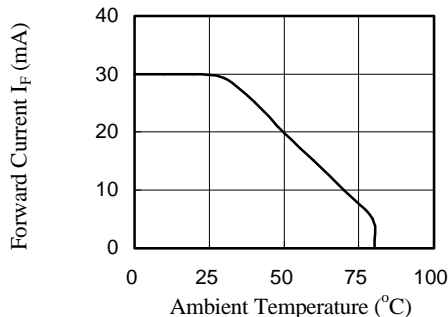

FIG.3 FORWARD CURRENT VS. AMBIENT TEMPERATURE

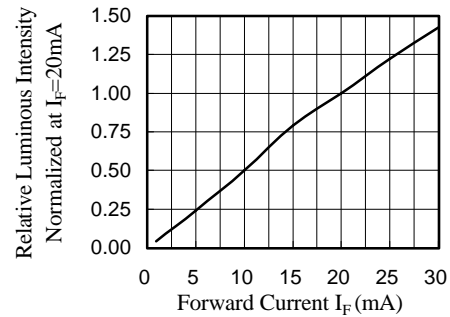

FIG.4 RELATIVE LUMINOUS INTENSITY VS. FORWARD CURRENT

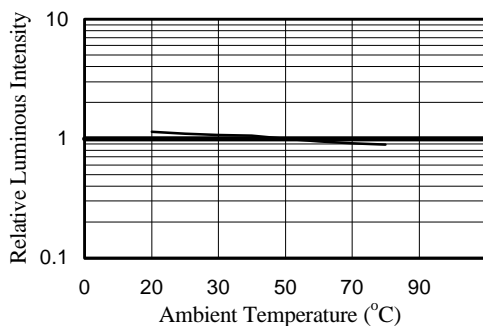

FIG.5 RELATIVE LUMINOUS INTENSITY VS. AMBIENT TEMPERATURE

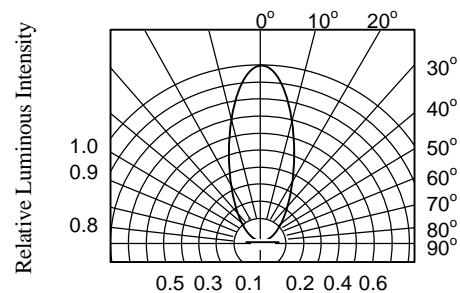

FIG.6 RADIATION DIAGRAM